

OASE GmbH
 Tecklenburger Straße 161
 D - 48477 Hörstel
 Phone: +49(0)54 54 – 800
 Fax: +49(0)54 54 – 80 322
 info@oase-livingwater.com
 www.oase-livingwater.com

Floating Fountain Illumination Set RGB 42641



Fresh water	Pool water	Sea water	220-240 V	400 V	110-120 V	50 Hz	60 Hz	12 V AC	24 V DC	DMX	DMX/RDM	Plug & Spray

Product characteristics at a glance:



- Robust IP68 spotlight with patented underwater connection technology
- RGB effects controllable via InScenio FM-Master WLAN EGC (App), WECS II 512/DMX/02, WECS II 1024/DMX/02, WECS II 2048/DMX/02
- Safe operation of the spotlight through 24 V DV low voltage, also in swim ponds
- Can be flexibly extended with up to 4 light fixtures per controller
- Spotlights, controller and cable are suitable for permanent underwater use to a depth of 4 m (protection class IP68, however standard regulations do not allow underwater use of the controller in swim ponds)
- Included in the scope of delivery:
 - 3x ProfiLux Garden LED RGB Spotlight
 - 3x holding bracket for light fixtures
 - 1x ProfiLux Garden LED Controller with 20 m cable
 - 20 m connecting cable EGC
- Accessories additionally required:
 - Control product: InScenio FM-Master WLAN EGC, WECS II 512/DMX/02, WECS II 1024/DMX/02, WECS II 2048/DMX/02

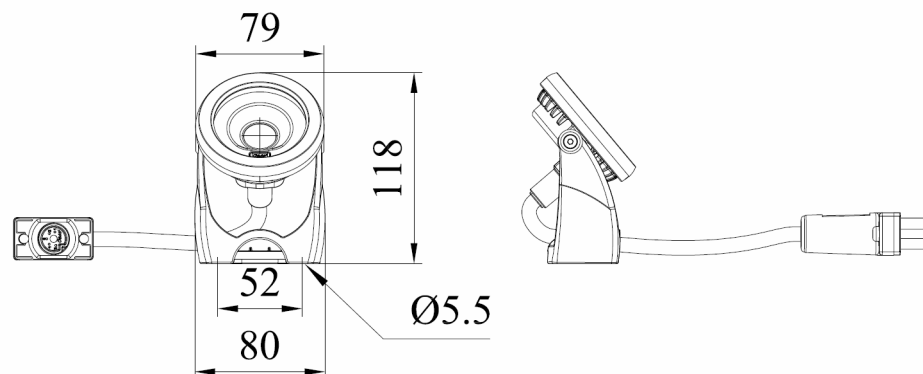

OASE GmbH
 Tecklenburger Straße 161
 D - 48477 Hörstel
 Phone: +49(0)54 54 – 800
 Fax: +49(0)54 54 – 80 322
 info@oase-livingwater.com
 www.oase-livingwater.com

Floating Fountain Illumination Set RGB 42621



Floating Fountain Illumination controlled via WECS II

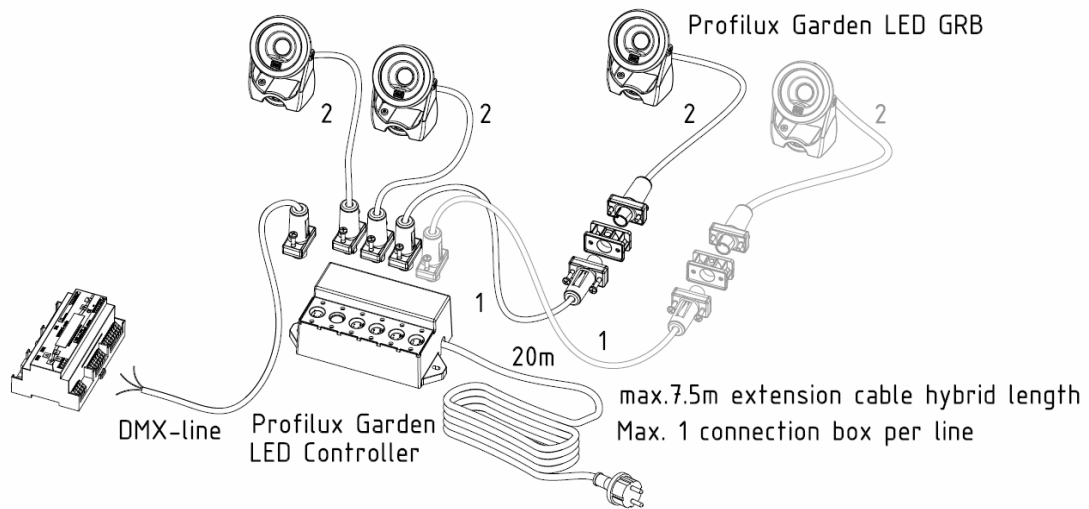

Floating Fountain Illumination controlled via InScenio FM-Master WLAN EGC

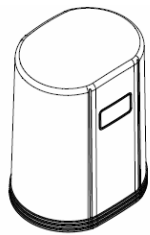

FM-Master WLAN EGC

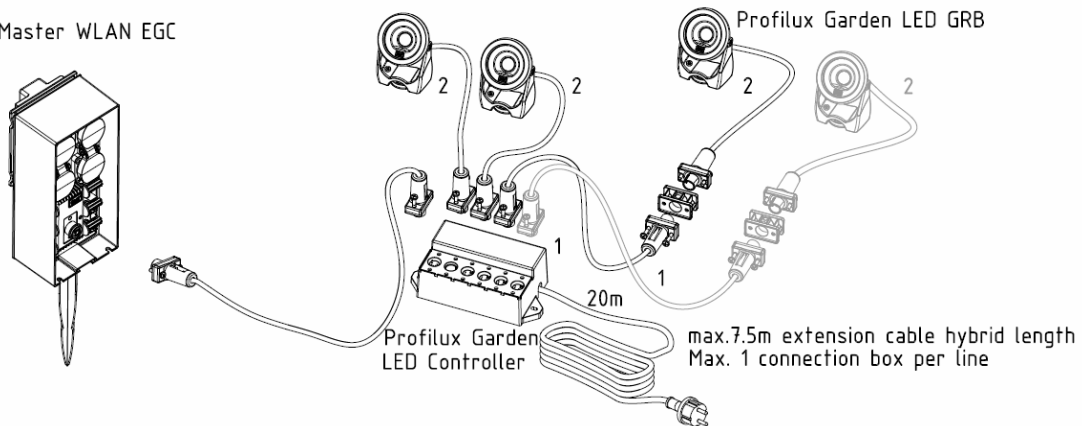
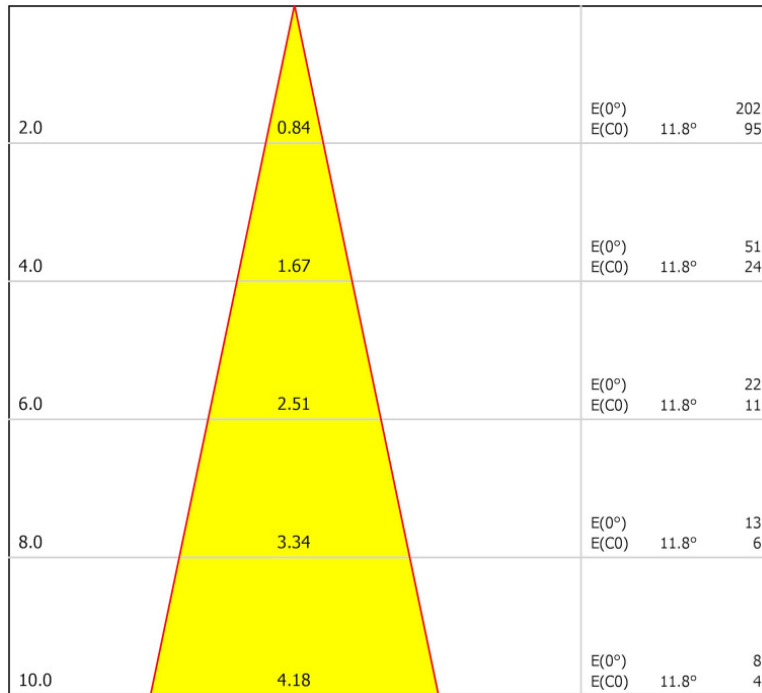
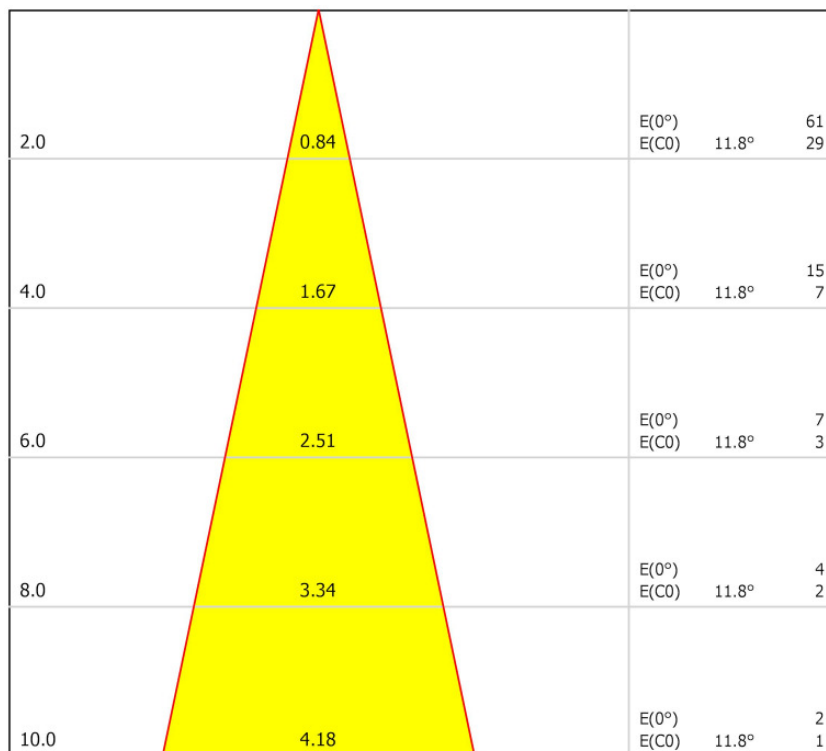

Diagram RGB all on; 213 lm



Distance [m] Cone Diameter [m] Illuminance [lx]
 — C0 - C180 (Half-value Angle: 23.6°)

Diagram red; 64 lm



Distance [m] Cone Diameter [m] Illuminance [lx]
 — C0 - C180 (Half-value Angle: 23.6°)

OASE GmbH
 Tecklenburger Straße 161
 D - 48477 Hörstel
 Phone: +49(0)54 54 – 800
 Fax: +49(0)54 54 – 80 322
 info@oase-livingwater.com
 www.oase-livingwater.com

Floating Fountain Illumination Set RGB 42641



Diagram green; 114 lm

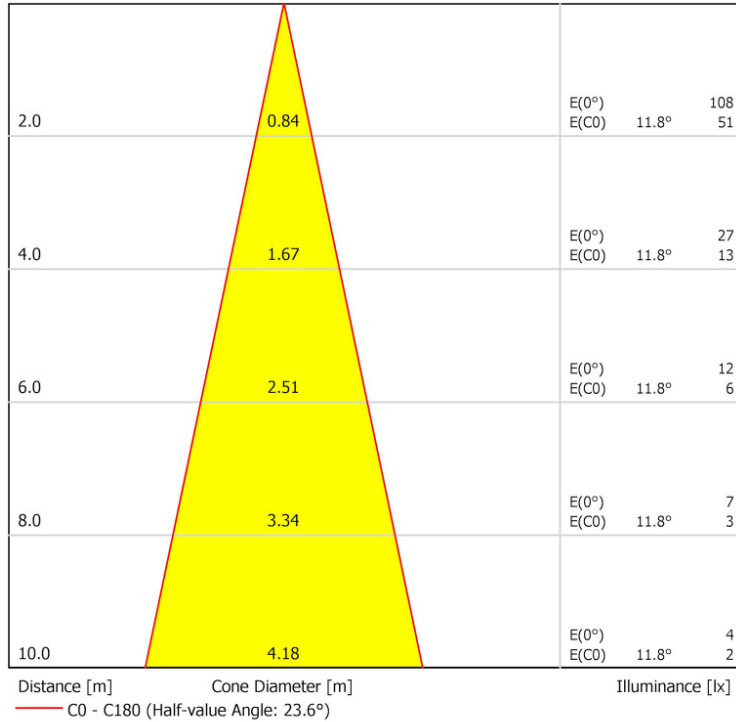
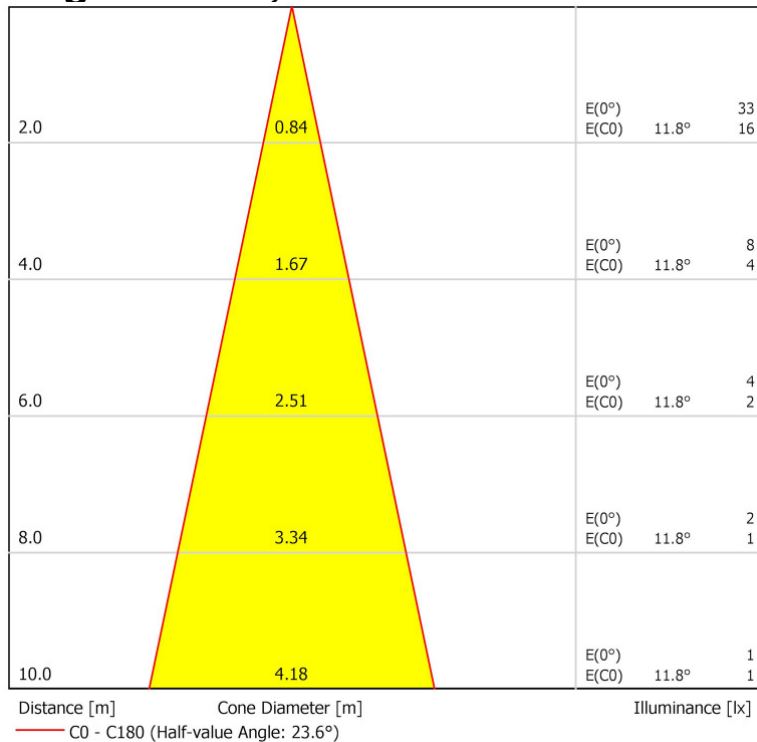

Diagram blue; 35 lm



The information contained in this data sheet is the sole property of OASE GmbH. Any reproduction in part or as a whole without the written permission of OASE GmbH is prohibited.

OASE GmbH
 Tecklenburger Straße 161
 D - 48477 Hörstel
 Phone: +49(0)54 54 – 800
 Fax: +49(0)54 54 – 80 322
 info@oase-livingwater.com
 www.oase-livingwater.com

**Floating Fountain
 Illumination Set RGB
 42641**



Floating Fountain illumination set RGB		
Luminous flux all on	lm	213
Luminous flux red	lm	64
Luminous flux green	lm	114
Luminous flux blue	lm	35
Beam angle	°	25
Strobe effect	Hz	25
Energy efficiency category		A
Weighted energy consumption	kWh/1000h	6.6
Rated voltage (primary, secondary)		230 V / 50 Hz, 24 V DC
Power consumption	W	6
Rated current	A	0.26
Dim frequency	Hz	2800
Power connection type		hybrid plug
Cable length	m	5
Protection class		IP 68
Dimensions (Ø x h)	mm	75.2 x 70
Material		stainless steel, plastic
Weight	kg	8.00
Order no.		42641